

Project :

Date :

Cat No. :

Type :

Notes :

Volts :

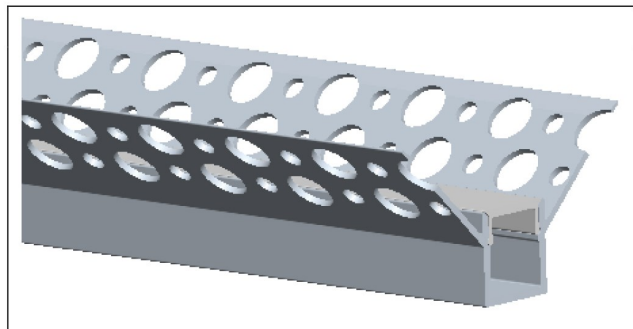

### Dimension

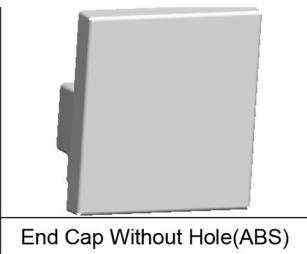
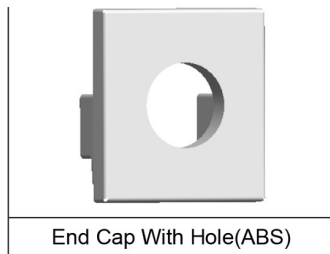
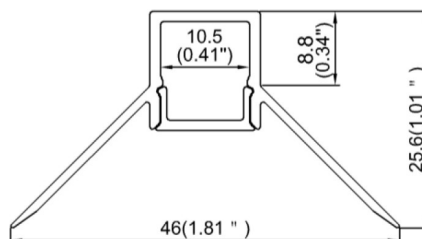

### Steps of Installation

1. Click the end caps

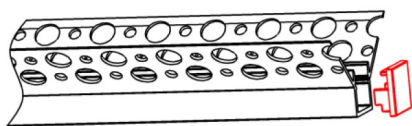

2. Mounting the profile

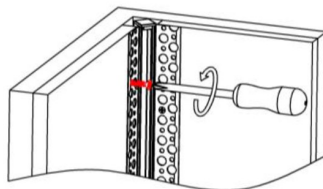

3. Plaster on the fixture & drywall

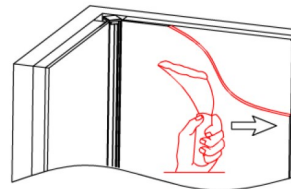

4. Painting on the fixture & drywall

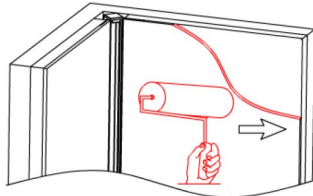

5. Stick the LED strip

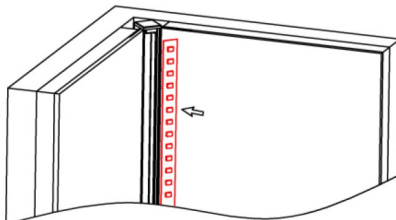

6. Click the diffused cover

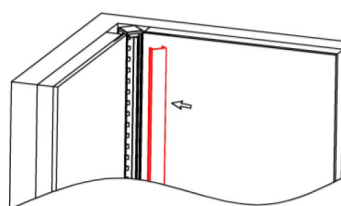

7. Installation completed

